

Fast, Effective Impact Cleaning

Toftejorg TZ-74 Rotary Jet Head

Application

The Toftejorg TZ-74 rotary jet head provides 360° indexed impact cleaning over a defined time period. It is automatic and represents a guaranteed means of achieving quality assurance in tank cleaning. The device is suitable for processing, storage and transportation tanks and vessels between 50 and 500 m³ (13,000 to 130,000 US gallons). Used in breweries, food and dairy processes and many other industries. The Toftejorg TZ-74 rotary jet head has been particularly successful in the brewing industry worldwide.

Working principle

The flow of the cleaning fluid makes the nozzles perform a geared rotation around the vertical and horizontal axes. In the first cycle, the nozzles lay out a coarse pattern on the tank surface. The subsequent cycles gradually make the pattern more dense, until a full pattern is reached after 8 cycles.

Cleaning Pattern

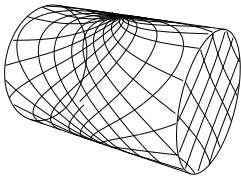

First cycle

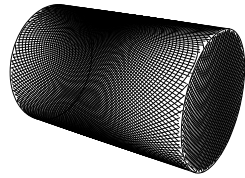

Full pattern

The above drawings show the cleaning pattern achieved on a cylindrical horizontal vessel. The difference between the first cycle and the full pattern represents the number of additional cycles available to increase the density of the cleaning.

Standard Design

The choice of nozzle diameters can optimise jet impact length and flow rate at the desired pressure. As standard documentation, the Toftejorg TZ-74 can be supplied with a "Declaration of Conformity" for material specifications.

Materials

1.4404 (316L), PTFE, PEEK, Tefzel, TFM



Technical Data

Weight:	6.1 kg (13 lbs)
Lubricant:	Self-lubricating with the cleaning fluid
Working pressure:	.3 - 12 bar (44 - 174 psi)
Recommended pressure:	.5 - 6.5 bar (72 - 94 psi)
Max. working temperature:	.95 °C (203 °F)
Max. ambient temperature:	.140 °C (284 °F)
Max throw length:	.7 - 24 m (23 - 79 ft)
Impact throw length:	.4 - 13 m (13 - 43 ft)
Standard thread:	.1 1/2" BSP or NPT, female

Caution

Do not use for gas evacuation or air dispersion.

Flow Rate

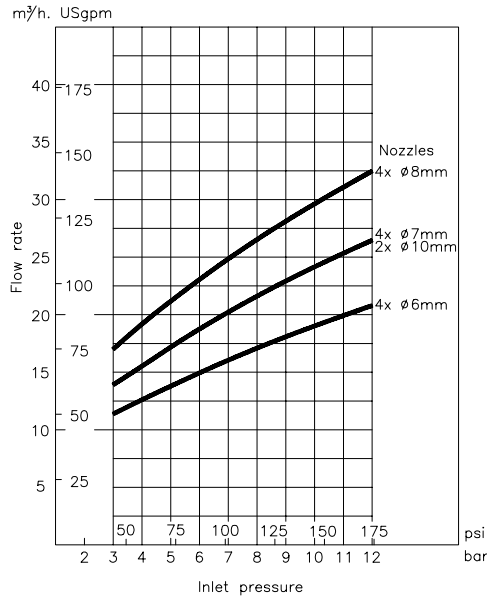

Impact Throw Length

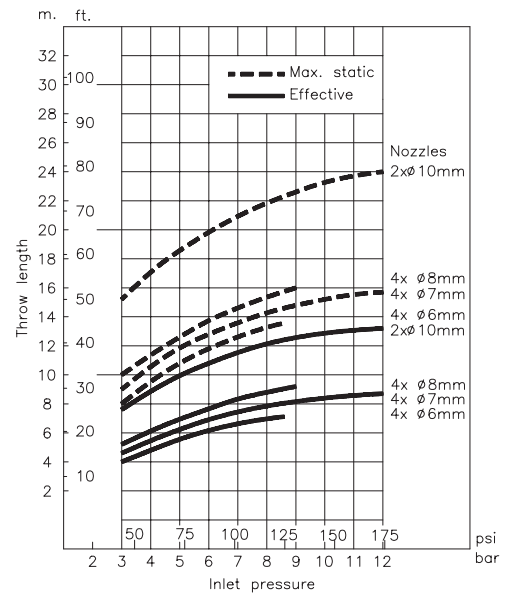

Dimensions (mm)

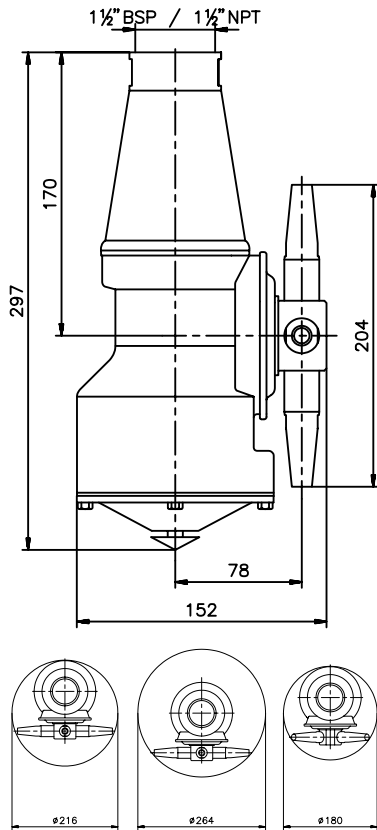

Cleaning Time, Complete Pattern

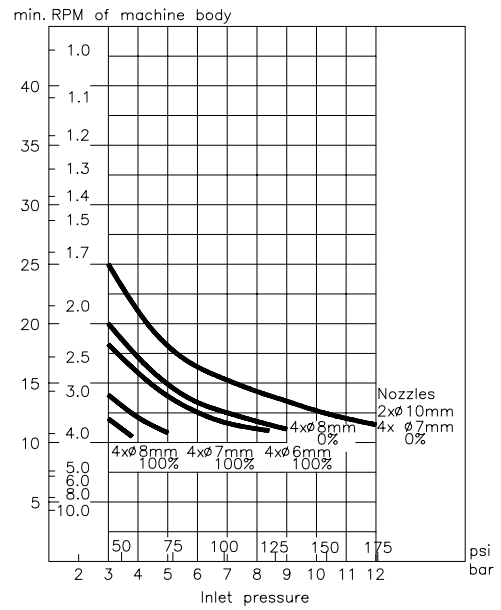

Ordering

Please specify nozzle size, inlet/guide configuration and connections and confirm application suitability

Options

- A. Electronic rotation sensor to verify 360° coverage
- B. Downpipe supporting flange

TRAX simulation tool

TRAX is a unique software that simulates how the Toftejorg TZ-74 performs in a specific tank or vessel. The simulation gives information on wetting intensity, pattern mesh width and cleaning jet velocity. This information is used to determine the best location of the tank cleaning machine and the correct combination of flow, time and pressure to implement.

A TRAX demo containing different cleaning simulations covering a variety of applications can be used as reference and documentation for tank cleaning applications. The TRAX demo is free and available upon request.

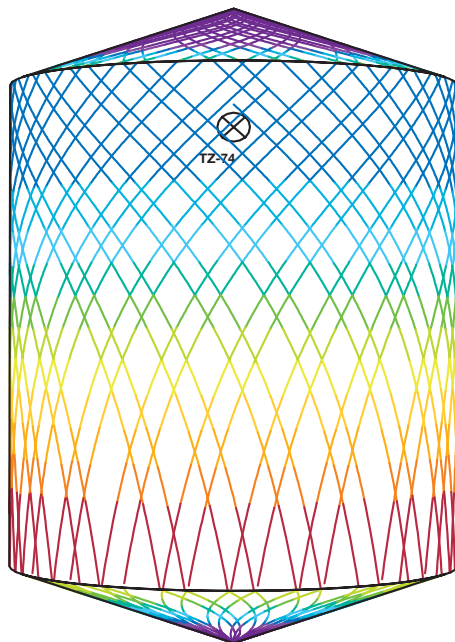
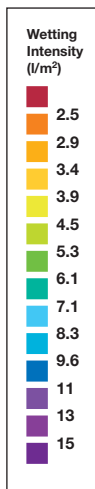

D5m H6m, Toftejorg TZ-74, 4 x 7 mm, 0% Time = 4.7 min.,
Water consumption = 1323 l



D5m H6m, Toftejorg TZ-74, 4 x 7 mm, 0% Time = 19 min.,
Water consumption = 5408 l