



FLOW
LEVEL
PRESSURE
ANALYTICAL
TEMPERATURE
INSTRUMENTATION
PASTEURIZATION CONTROLS

"SL" Level Transmitter

**New technology proven to eliminate long-term signal drift —
provides substantial savings in all inventory applications!**

- *Fewer tune-ups*
- *No more overflows*
- *More reliable inventories*
- *3-A compliant; Third party verified in accordance with standard 74-02*

Special Features Include:

- *Quick Disconnect Receptacles with optional Field Wiring Connectors*
- *One-Touch Field Calibration*
- *Available with HART Communication*

Anderson Instrument Company's "SL" Level Transmitter is the latest innovation for measuring liquid level in sanitary applications. The "SL" Transmitter incorporates state of the art design to provide superior accuracy and long term signal stability. The field tested performance of the "SL" transmitter means the elimination of expensive, repetitive re-calibrations along with protection against costly overflow/run-dry situations that can occur with less

stable level transmitters. The 0.2% accuracy experienced at installation can now be expected a year later!

We've also incorporated a field calibration feature that provides "one-touch" sensor zeroing as well as simple range calibration, without the need for special tools and fixtures, pressure sources, or removal of the transmitter from the tank. This translates to real cost savings during installation or when adjusting for new

application requirements. With the addition of our standard quick disconnect receptacles; we have even extended our two-year warranty to cover water ingress.

Of course the "SL" Transmitter is available in all standard fitting and range combinations you'll need to fit any sanitary tank application. All variations are CE compliant, meet applicable 3-A Sanitary Standards, and are backed by a 2-year warranty.

APPLICATIONS

- **Inventory Control**
- **Batching/Mixing Control**
- **Both Conductive and Non Conductive Fluids**



ANDERSON INSTRUMENT CO., INC • 156 AURIESVILLE RD. • FULTONVILLE, NY 12072 • USA • 800-833-0081 • FAX 518-922-8997
ANDERSON INSTRUMENT CO. LP • 400 BRITANNIA RD. EAST, UNIT 1 • MISSISSAUGA, ONTARIO L4Z 1X9 • CANADA • 905-568-1440 • FAX 905-568-1652
NEGELE MESSTECHNIK GmbH (A Division of Anderson) • RAIFFEISENWEG 7 • D-87743 EGG A. D. GÜNZ • GERMANY • +49 (0) 8333/9204-0 • FAX +49 (0) 8333/9204-49
MAIDA INTERNATIONAL (LATIN AMERICA & ASIA) 516-676-3079 • FAX 516-676-3199

SL Specifications

Performance

Level Measurement Ranges: (Factory calibrated at no charge and easily field calibrated within the parameters listed below)

	Minimum	Maximum (URL*)	Proof Pressure
SL1 & SL5 Series	0-30 " w.c.**	0-140 " w.c.	10 psig
SL2 & SL6 Series	0-140.1 " w.c.	0-415 " w.c.	30 psig
SL3 & SL7 Series	0-415.1 " w.c.	0-830 " w.c.	60 psig
SL4 & SL8 Series	0-830.1 " w.c.	0-1385 " w.c.	100 psig

Calibrated Accuracy: (includes repeatability, hysteresis, and linearity)
 $\pm 0.20\%$ of URL at stable calibration temperature

Calibration Stability: Within $\pm 0.2\%$ of URL for one (1) year minimum

Resolution: Infinite
 Process Temperature Limits: 0°F to 265°F (-18°C to 130°C)
 Ambient Temperature Limits: 15°F to 120°F (-9°C to 49°C)
 Compensated Temp. Range: 0°F to 250°F (-18°C to 121°C) (process)

Temperature Stability: $\pm 0.2\%$ of Upper Range Limit (URL) per 10°F

Over-Range Capacity: 2 times the URL (see table above)
 Response Time: 526 mSec

* URL = Upper Range Limit
 ** w.c. = water column

Power Signal

Loop Power (excitation): 12-40 vdc
 Output: 4-20mA dc, 2-wire. Internal test points supplied

Loop Resistance: 1550 ohms (max.) at 40 vdc, 750 ohms (max) at 24 vdc

Cable Recommended: 2 conductor, stranded, 18-24 AWG, shielded with ground.
 0.17 - 0.26" Cable Sheath OD for use with field wiring connector.
 Shielded molded cord set recommended for best lightning strike protection.

Receptacle: 5-pin M12 Quick Disconnect Receptacle

Materials/Construction

Housing Material: 304 and 316 stainless steel finished to 32R_a max

Wetted Parts: 316L stainless steel electropolished to 15R_a max

Ratings: NEMA 4X, IP-66, IP-67

Agency Approvals

Electromagnetic Compatibility (EMC): Fully CE Compliant when equipped with shielded molded cord set

Standards: Complies with all applicable provisions of 3-A Sanitary Standards (74-02)

Designed and manufactured to sound engineering practices in accordance with Article 3.3 of the PED 97/23/EC

Warranty: All units are covered by a two (2) year warranty against defects in material and workmanship when installed and maintained according to the instruction manual provided

0.17-0.26" Cable Sheath Diameter

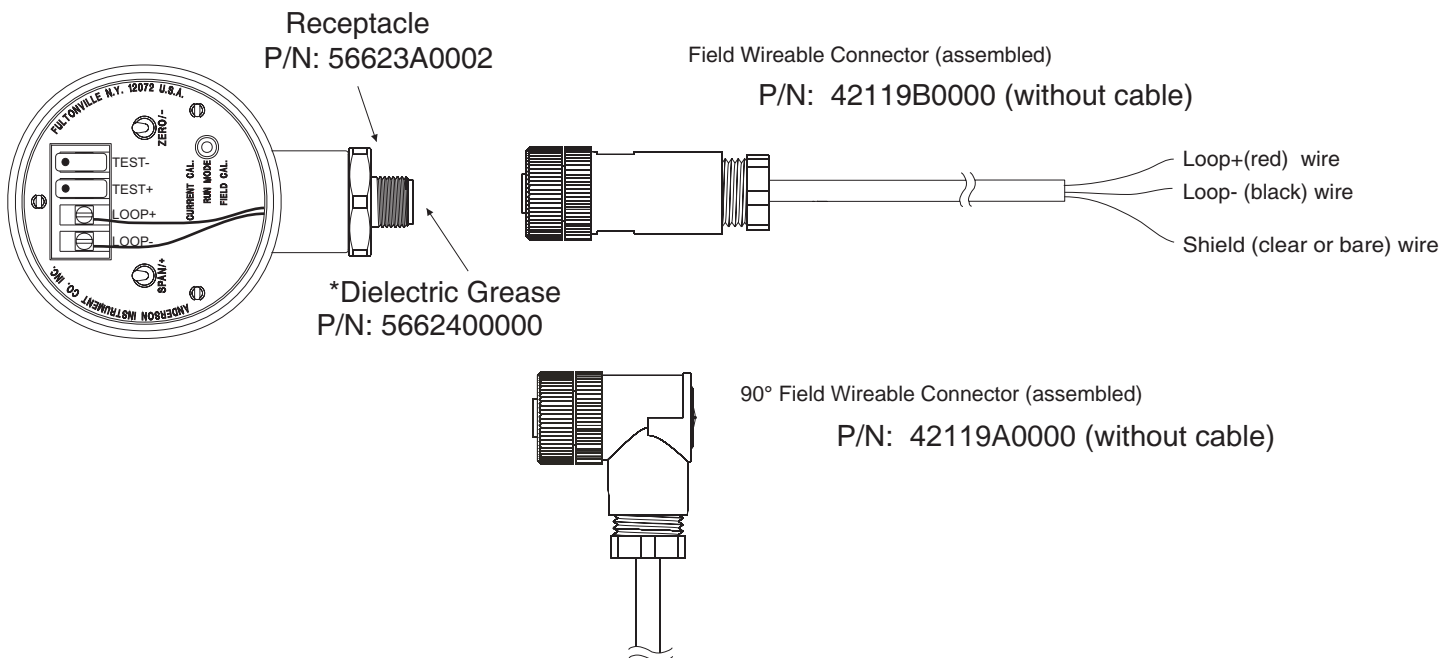

How to Order



SPAN RANGE

- 1 0-30" min to 0-140" max with HART
- 2 0-140.1" to 0-415" max with HART
- 3 0-415.1" to 0-830" max with HART
- 4 0-830.1" to 0-1385" max with HART
- 5 0-30" min to 0-140" max
- 6 0-140.1" to 0-415" max
- 7 0-415.1" to 0-830" max
- 8 0-830.1" to 0-1385" max

FITTING

- 089 Anderson Flush Mount Long (71060-A3, A5, A7, A9)
- 088 Anderson Flush Mount Short (71060-A4, A6, A8)
- 091 Cherry Burrell Flush Mount Long (insulated tank)
- 090 Cherry Burrell Flush Mount Short (uninsulated tank)
- 092 King Gage Flush Mount Long (1777-3)
- 093 King Gage Flush Mount Medium (1777-1, -6 Standard)
- 094 King Gage Flush Mount Short (1777-2 non-insulated)
- 097 Tank Mate Flush Mount Long* (208WVE)
- 096 Tank Mate Flush Mount Medium* (205WVE)
- 095 Tank Mate Flush Mount Short* (200WVE)
- 004 1-1/2" Tri-Clamp
- 005 2" Tri-Clamp
- 059 1-1/2" NPT
- 147 Continental (long)
- 146 Continental (short)
- 141 Rosemount / Foxboro Sanitary Spud - Short
- 142 Rosemount / Foxboro Sanitary Spud - Long
- 154 Endress & Hauser Universal Adaptor - Short
- 155 Endress & Hauser Universal Adaptor - Long
- 169 Liquid Scale Flush Mount Medium†

DIAPHRAGM

- 1 SS-316L Electropolished
- 2 Hastelloy "C"
(NOT available on fittings: 092, 093, 094, 097, 096, 095, 154 and 155)

* Requires Tank Mate Shell Adaptor:
57200A0001 (insulated)
57200A0002 (uninsulated)

† Requires Liquid Scale Shell Adaptor:
4593600000

**Note:

Calibration of span is in units "inches water column".
Consult factory for assistance.

***Note:

Orders not accepted without calibration data or completed worksheet.

CALIBRATION ***

Height in inches w.c.**
(to nearest tenth)
00000 Field Calibrated

Examples:

10850 1,085.0 inches
00305 30.5 inches

SENSOR WIRING

Straight FWC Options

- 01 QDR & Field Wiring Connector (FWC) w/No Cable (Std.)
- 00 Quick Disconnect Receptacle (QDR) w/No Cable, No FWC
- 05 QDR & FWC w/25 ft Cable
- 10 QDR & FWC w/50 ft Cable
- 15 QDR & FWC w/75 ft Cable
- 20 QDR & FWC w/100 ft Cable
- 21 QDR & FWC w/125 ft Cable
- 22 QDR & FWC w/150 ft Cable
- 23 QDR & FWC w/175 ft Cable
- 24 QDR & FWC w/200 ft Cable
- 99 No QDR, no FWC and no Cable (No sensor warranty for water damage)

90° FWC Options

- R0 QDR & 90° FWC w/No Cable
- R1 QDR & 90° FWC w/25 ft Cable
- R2 QDR & 90° FWC w/50 ft Cable
- R3 QDR & 90° FWC w/75 ft Cable
- R4 QDR & 90° FWC w/100 ft Cable
- R5 QDR & 90° FWC w/125 ft Cable
- R6 QDR & 90° FWC w/150 ft Cable
- R7 QDR & 90° FWC w/175 ft Cable
- R8 QDR & 90° FWC w/200 ft Cable

Molded Cord Set Options

- S1 QDR w/25 ft Shielded Cord set
- S2 QDR w/50 ft Shielded Cord set
- S3 QDR w/75 ft Shielded Cord set
- S4 QDR w/100 ft Shielded Cord set

MOUNTING

- 0 Horizontal
- 1 Vertical
- 2 Other (specify angle from vertical or from horizontal)

ACCESSORIES

Anderson Weld-In Shells for Flush Mount Level Transmitters

- 71060A0003 Insulated Vessel - Standard Flange - 316L
- 71060A0004 Uninsulated Vessel - Standard Flange - 316L
- 71060A0005 Insulated Vessel - Pressure Vessel Flange - 316L
- 71060A0006 Uninsulated Vessel - Pressure Vessel Flange - 316L
- 71060A0009 Insulated Vessel - H/D Press. Vessel Flange - 316L

Shell Adaptor

- Tank Mate, uninsulated #57200A0002
- Tank Mate, insulated #57200A0001

Gaskets for Flush Mount Level Transmitters

- Anderson #44348A0001
- Cherry Burrell #44292A0001
- King Gage #36240S0212
- Tank Mate #36240S0123
- Continental #5658900000

Sensor Calibration Adaptors

- Anderson fitting #73198A0001
- Cherry Burrell fitting #73198A0002
- King Gage Fitting #73198A0003
- Tankmate #73198A0004

Sensor Fittings and Dimensions

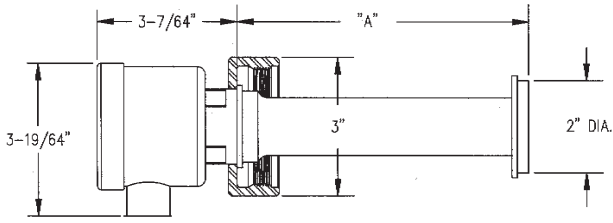

ANDERSON SHELL TYPE	"A"
NON INSULATED	2-3/16
INSULATED	6-1/2

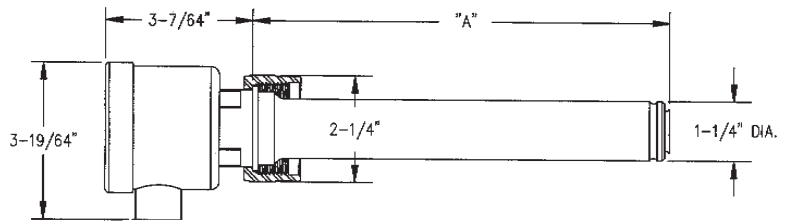

KING SHELL TYPE	"A"
NON INSULATED	2-3/16
STANDARD	6-9/16
LONG	8-13/16

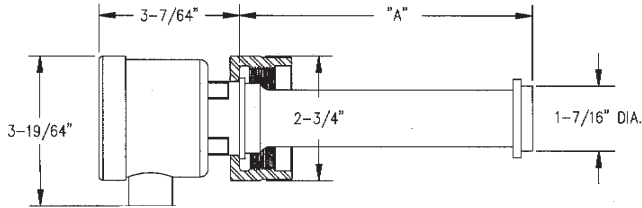

CHERRY BURRELL SHELL TYPE	"A"
NON INSULATED	2-3/16
INSULATED	6-1/2

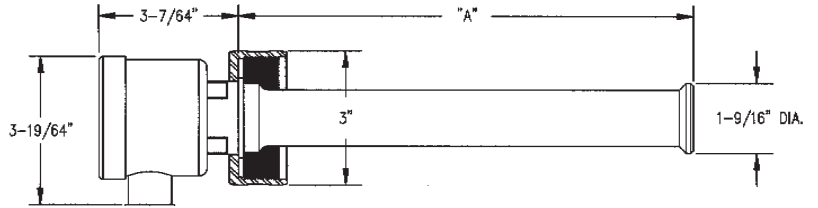

TANK MATE SHELL TYPE	"A"
SHORT	5-7/32
MEDIUM	7-19/64
LONG	10-3/16

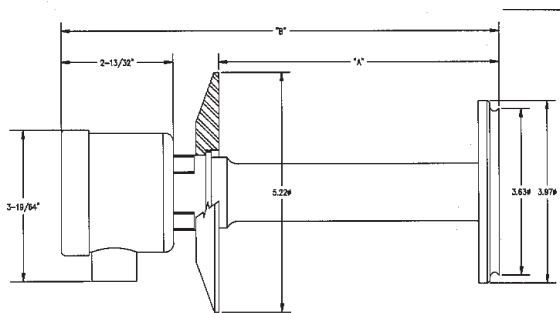
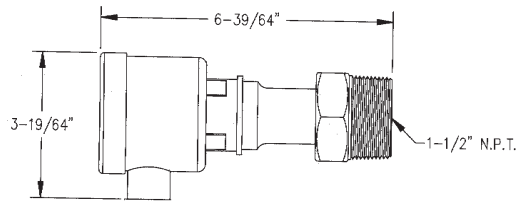
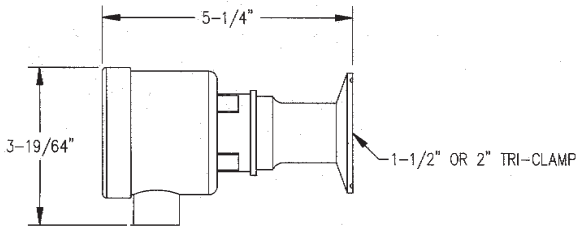

FITTING	"A" DIM.	"B" DIM.
ROSEMOUNT SHORT	2.11"	5-1/2"
ROSEMOUNT LONG	6.11"	9-1/2"

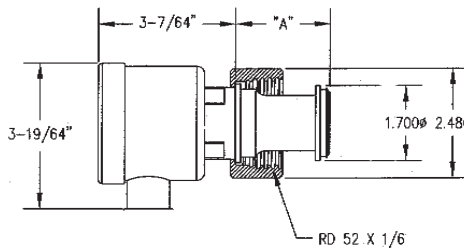

DESCRIPTION - USE	"A" DIM.
E+H LONG (6" SHELL)	6.60
E+H SHORT (1-9/16" SHELL)	2.16

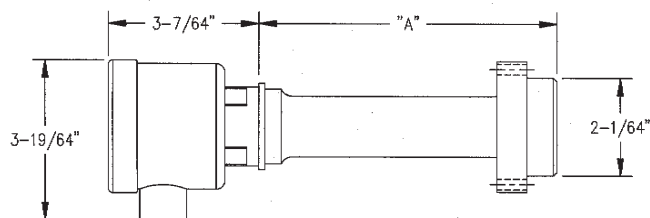

CONTINENTAL SHELL TYPE	"A"
NON INSULATED	2-5/32
INSULATED	6-3/16